

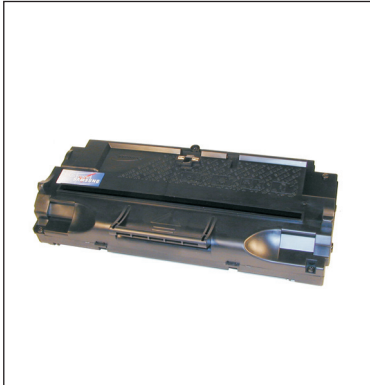

TECHNICAL DOCUMENT

Disassembly Instructions

Samsung SF-555P Toner Cartridges



First released in June 2003, Samsung SF-555P fax machines are loosely based on the Samsung SF-5100 engine, (which is a modified version of the Samsung ML-1210). The SF-555P runs at 12 ppm with a maximum resolution of 600 dpi.

Samsung has been releasing quite a few machines lately, and this is one of the latest batch. In a recent PC magazine (7/2003) article on service and reliability, Samsung actually beat HP in the monochrome printer segment. They took second overall to HP. Samsung machines are rapidly growing in popularity. They have a long way to go before they can challenge HP as far as placements go, but by keeping the costs low and the quality high, it seems that they are determined to get there.

The SF-550D3 cartridge looks similar to the SF-5100, but is different enough to warrant it's own separate instruction. One very interesting thing is that although the cartridges are physically different, if a Lexmark E210 machine is modified as shown in our ML-1210 instructions, the SF-550D3 cartridge can be tested in it. For some

of the physical differences between the cartridges, see Figure's 1 & 2. We will repeat the Lexmark E210 machine modification instructions at the end of this article.

These cartridges do not have a drum cover, and come new with a piece of heavy paper taped around the cartridge. (See Figure 3) The SF-550 also does not use a seal. All new cartridges opened so far have shown some toner leakage that would have shown on any prints.

The standard cartridge (Samsung part# SF-550D3/XAA comes new with 90g toner, and is rated for 3,000 pages at 4% coverage. It appears that Samsung has discovered our industry, the top of the cartridge is embossed with Samsung all over it. Samsung cartridges all now come with a card that states the cartridge is a genuine Samsung. This card also gives the Model #, Serial #, and Production date. See Figure's 4 & 5



Figure 1



Figure 2

Samsung SF-555P Toner Cartridges (Continued)



Figure 3



Figure 4



Figure 5

Required Tools

- 1) Toner approved vacuum.
- 2) A small Common screw driver
- 3) A Phillips head screwdriver
- 4) Needle nose pliers

Required Supplies

- 90g Toner
- Fuse: 63mA, 250V, 5x20mm, fast acting glass type
- New Drum (Recommended) (ML-1210)
- New PCR (Optional)(ML-4500)
- New Developer Roller sleeve (Optional) (ML-4500)

Samsung SF-555P Toner Cartridges (Continued)

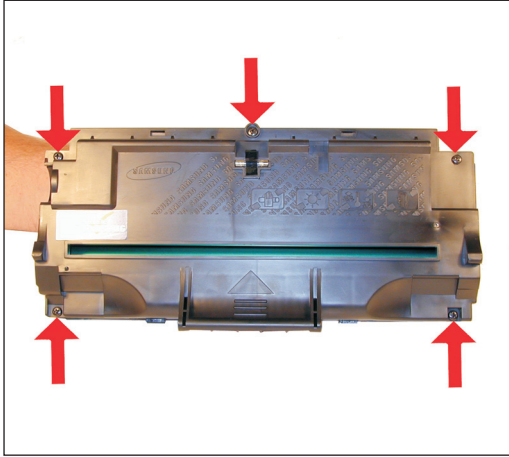

Figure 6

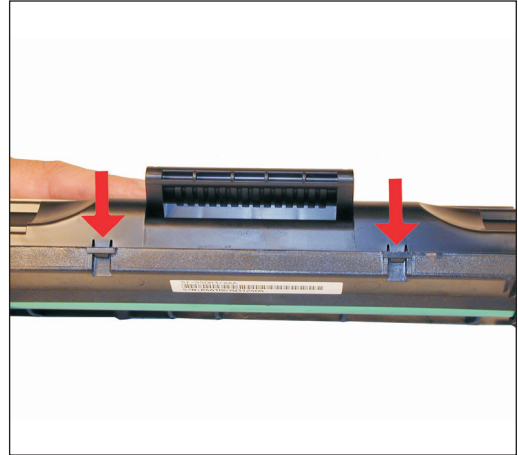

Figure 7

- 1) Place the cartridge with the handle facing up. Remove the 5 top cover screws. See Figure 6
- 2) Underneath the handle of the cartridge to the right and left, there are 2 plastic tabs GENTLY press them in, and lift the cover off. See Figure 7

CAUTION: The upper half of the toner hopper is being removed. If there is a lot of toner left in the hopper, it can dump out all over! Vacuum the hopper clean.

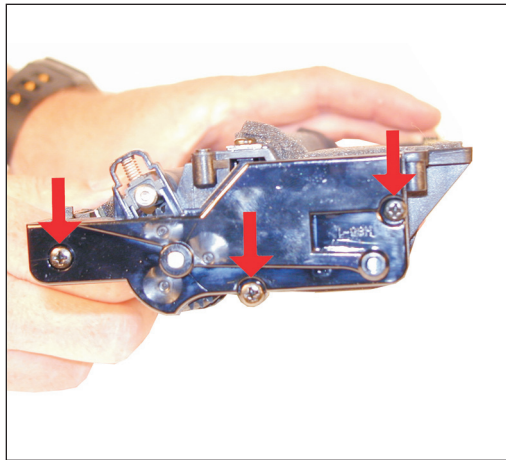

Figure 8

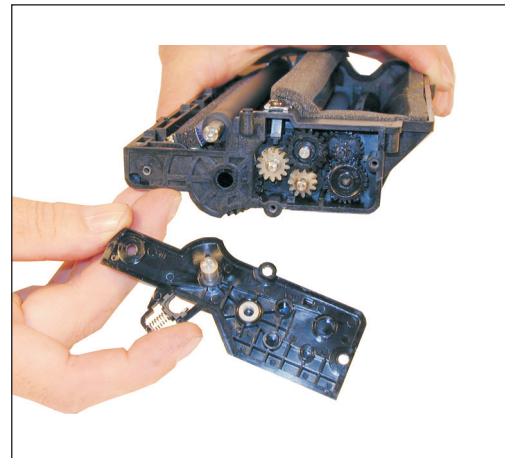

Figure 9

- 3) With the toner hopper facing away from you, remove the three screws on the right side end cap. Remove the end cap. See Figure's 8 & 9

Samsung SF-555P Toner Cartridges (Continued)

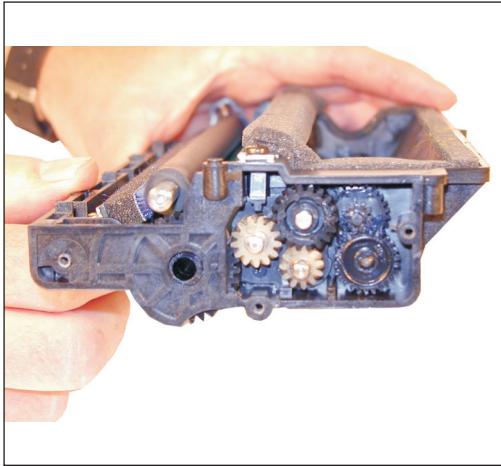

Figure 10

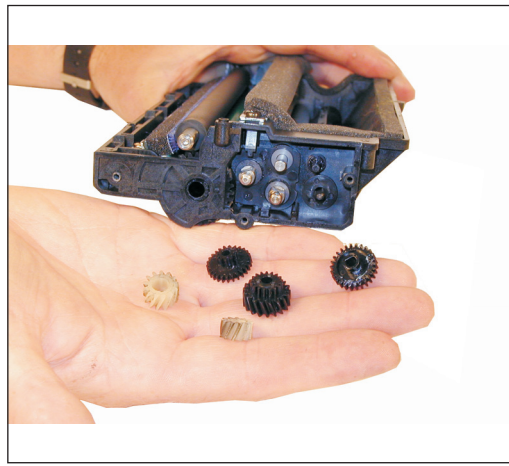

Figure 11

4) Also on the right side there is a series of gears under the end cap. Make a note of the location of each gear, and remove them. See Figure's 10 & 11

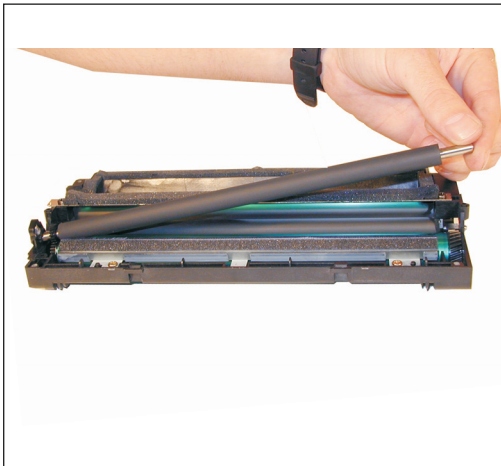

Figure 12

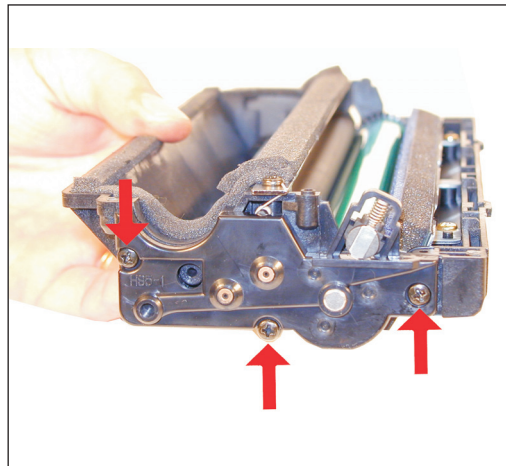

Figure 13

5) Remove the PCR. See Figure 12

6) Clean the PCR with your normal PCR cleaner.

WARNING: Do not clean the OEM PCR with alcohol, as this will remove the conductive coating from the roller. If the PCR is an aftermarket, follow the cleaning methods recommended by the manufacturer. If the PCR is an OEM, we recommend it be cleaned with your standard PCR cleaner.

7) With the toner hopper away from you, remove the three screws on the left side end cap. Remove the end cap. See Figure 13

Samsung SF-555P Toner Cartridges (Continued)

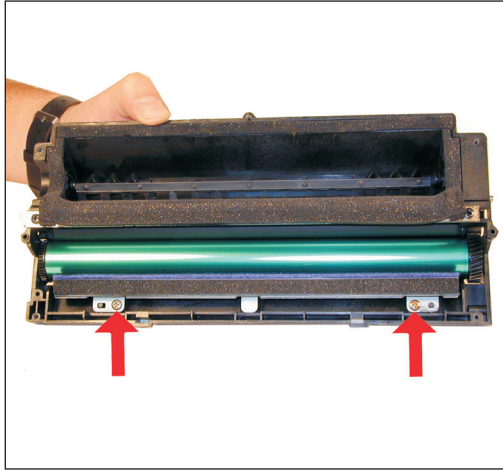

Figure 14

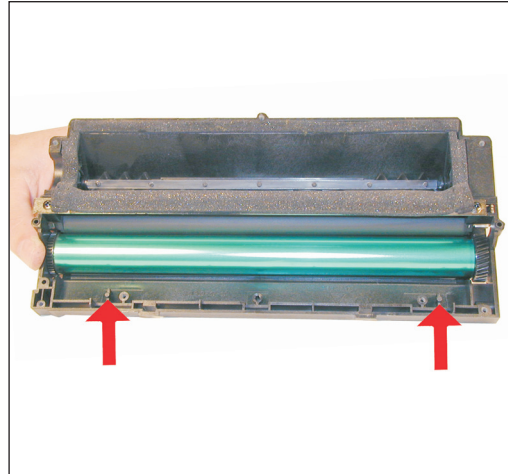

Figure 15

8) There are 2 Gold Colored screws on the PCR cleaner Assy. Remove them and gently pry the blade up. Be very careful not to break off the alignment tabs. We have found it best to lift up from both sides when removing this blade. Note that these screws have a different length than the black screws. See Figures 14 & 15

9) It is very important that the PCR cleaner be cleaned. Vacuum or blow off any residual toner from the foam/felt.

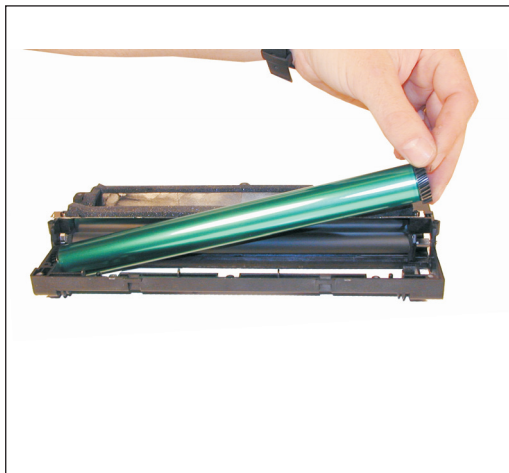

Figure 16

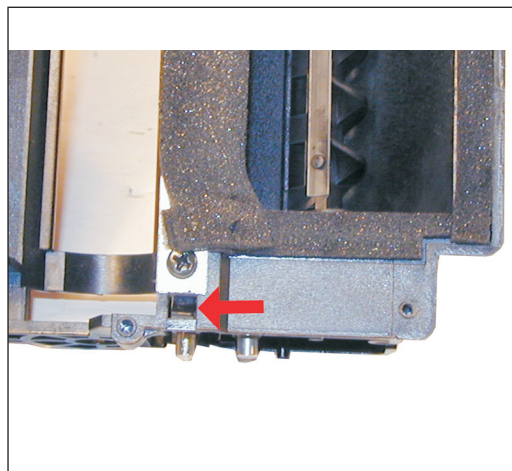

Figure 17

10) With the PCR Cleaner Assembly removed, the drum can easily be removed by lifting it out. See Figure 16

11) Clean out any remaining toner from the cartridge.

12) Press in on the top tab of the Developer roller plate (Right Side) to release it. See Figure 17

Samsung SF-555P Toner Cartridges (Continued)

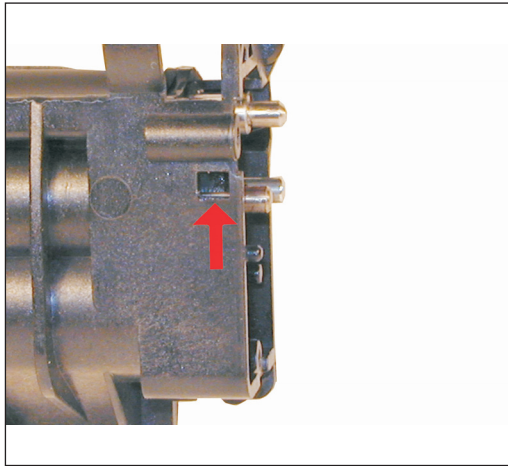

Figure 18

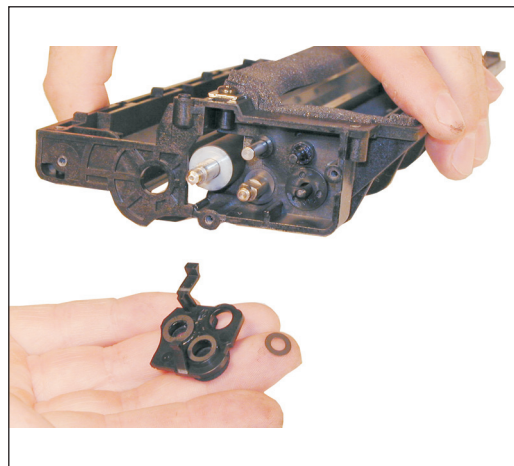

Figure 19

13) Press in on the bottom tab of the Developer roller plate to release it. See Figure 18

14) Gently pry out the roller plate from the cartridge. The foam seal, and plastic flat washer will come out with it. Be careful not to damage the foam seal, or loose the flat washer. See Figure 19

15) Remove the Developer Roller.

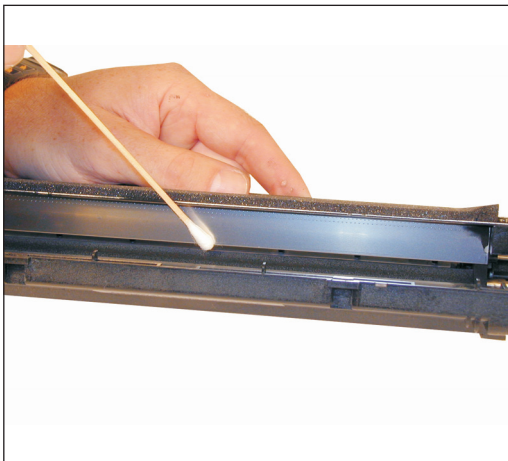

Figure 20



Figure 21

16) It is highly recommended that the Doctor Blade be cleaned. Failure to do so will cause streaking. The Doctor Blade can be cleaned with out removing it. Dampen a cotton swab with alcohol, and clean the blade. Be careful not to press too hard and damage the blade. If the blade has a heavy buildup of toner on it, clean it with Acetone, and then alcohol. Removing the blade is difficult because of the foam seals attached. If the seals are torn, the cartridge will leak. That is why we do not recommend it. Once replacement Dr. Blades are available, they will have to come with replacement foam. See Figure 20

17) Replace the Developer roller, roller plate and gears. If no grease is left or it is contaminated with toner, clean it all off, and replace it with white lithium grease. Be sure to clean and grease the gear shafts, and inside the gear.

18) Install the new drum in place. See Figure 21

Samsung SF-555P Toner Cartridges (Continued)

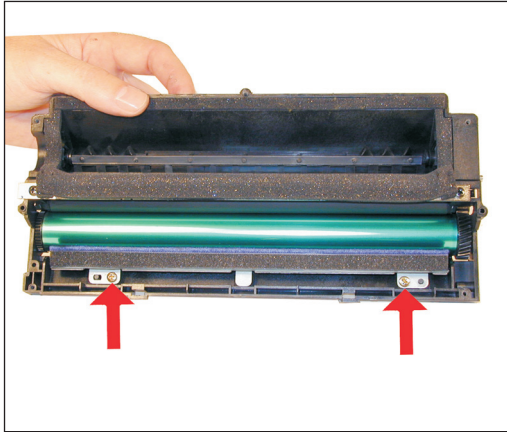

Figure 22

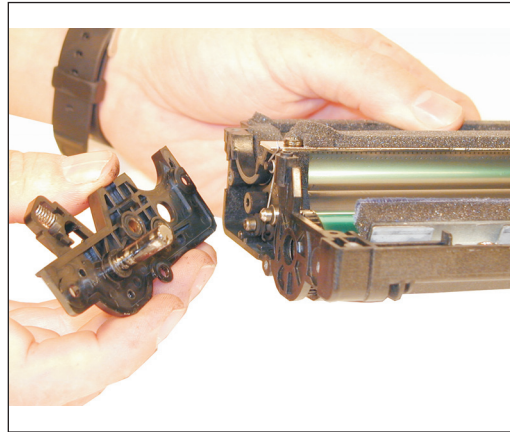

Figure 23

19) Install the PCR cleaner Assy. and two Gold Colored screws. See Figure 22

20) Clean the conductive grease off the left side (Non Gear) end cap and replace with fresh grease. Replace the end cap and three screws. See Figure 23

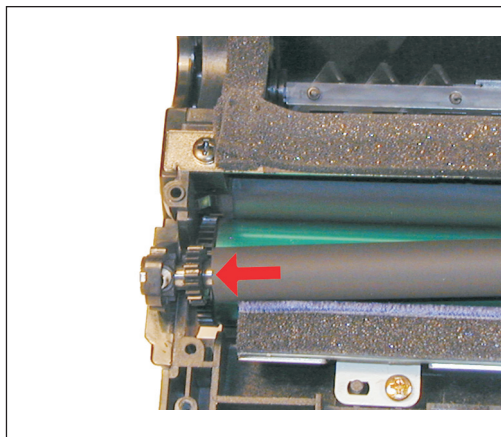

Figure 24

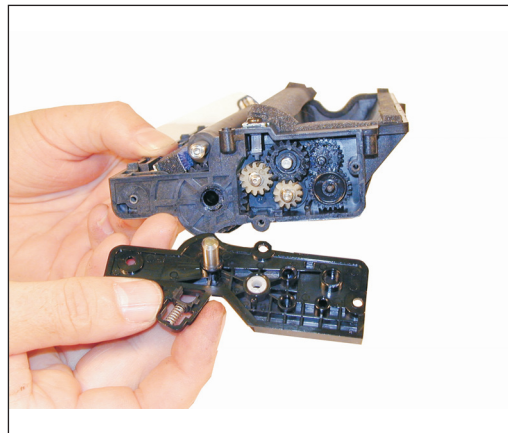

Figure 25

21) Install the PCR. See Figure 24

22) Install the 5 gears, right side end cap, and screws. Make sure the PCR fits correctly in its holder, and all the gears are aligned. See Figure 25

Samsung SF-555P Toner Cartridges (Continued)

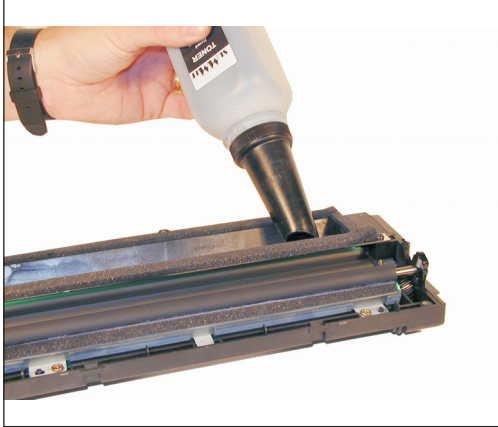

Figure 26

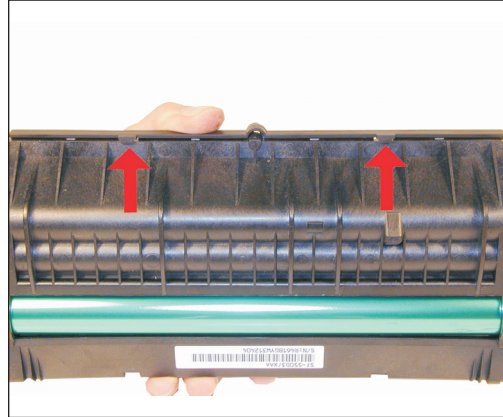

Figure 27

23) Fill the hopper with 90g of the SF-550 toner. See Figure 26

This can also be done through the fill plug, but the fill plug tends to leak and will probably have to be sealed with silicon.

24) Carefully snap the cover on making sure all the tabs lock in place. See Figure's 27 & 28

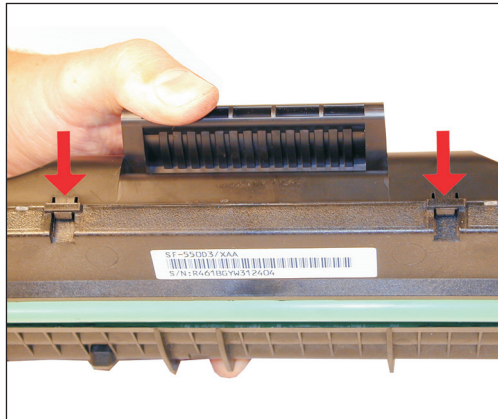

Figure 28

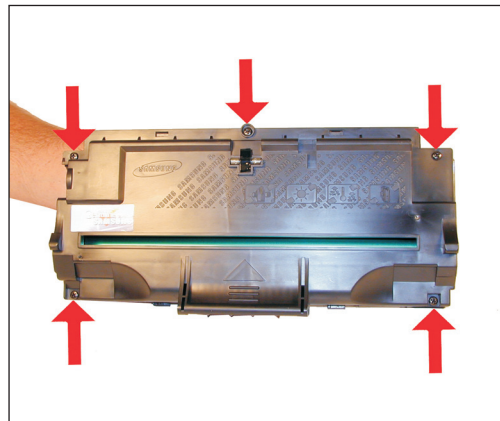

Figure 29

25) Install the five screws in the top cover. See Figure 29

Samsung SF-555P Toner Cartridges (Continued)

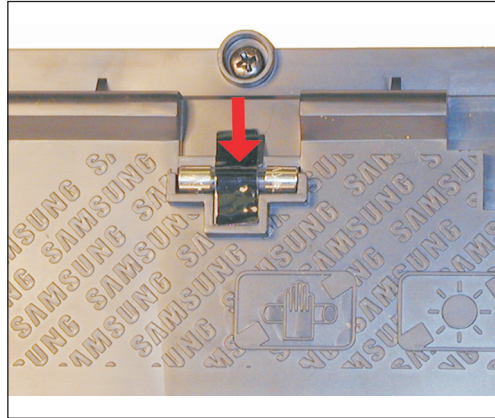

Figure 30

26) Replace the fuse on the top of the cartridge with a new 63mA fuse. The fuse should be taped in place to it does not fall off. See Figure 30

Running a cleaning page

The SF-555P has the ability to run it's own cleaning page. This page according to Samsung will clean any toner particles off the drum that may be stuck there.

Press the SETUP key on the front panel.

Press the Right or Left ARROWS until "MAINTENANCE" appears.

Press the START/ENTER key.

The display will show "CLEAN DRUM"

Press the START/ENTER key.

A Cleaning page will then print.

Cleaning the Scanner

These machines can also be adjusted for a dirty scanner. Personally I would just clean it, but there may be a time where this procedure becomes useful (When the scanner starts to fail) so I am including it here.

Load a sheet of CLEAN bright white paper into the scanner

Press the SETUP key on the front panel.

Press the Right or Left ARROWS until "MAINTENANCE" appears.

Press the START/ENTER key.

Press the Right or Left ARROWS until "ADJUST SHADING" appears.

Press the START/ENTER key.

Samsung SF-555P Toner Cartridges (Continued)

Printing a Test page:

The best way to run test pages is simply to make a copy. Take a printed page with both text and graphics, and run a few copies.

Cleaning the machine:

Other than the cartridge bay, the document feed rollers and scanner must also be cleaned. Although the adjustment listed above will take care of dirty copies, this is by far a better way to go.

Lift up the top cover. There is a white roller attached to the lid. Rotate the right side of the roller until the bushing allows the roller to be removed. Clean the roller with a soft lint free cloth and water. DO NOT use any chemicals on this roller! Re-install the roller, lock the bushing in place.

In the center of the lid is the ADF separation pad. Clean the rubber with a good rubber cleaner.

The scanner glass is located at the base of the lid on the body of the machine. Clean it with a soft lint free cloth. If stubborn dirt will not come off, dampen the cloth with water, and dry the glass. It is not recommended that anything harsher than water be used on the glass. Be careful not to scratch the glass!

Common Cartridge Problems

A **Dirty or Bad Primary Charge Roller (PCR)**; located inside the cartridge, this will show on the test print as vertical gray streaks down the page, as a gray background throughout the page, as ghosting where part of a previously printed area is repeated, or as a mark that repeats every **37mm**.

Dirty PCR Connection; This will show as horizontal dark black bars across the page, or as shading throughout the page.

Scratched Drum; This is shown by a very thin, perfectly straight line that runs from the top to the bottom of the test page.

Chipped Drum; This will show as a dot or series of dots that repeat every **75mm**.

Light Damaged Drum; This will show up as a shaded area on the test print that should be white. Again this will repeat every **75mm**.

Bad Wiper Blade; This will show as either a gray line approximately 1/8" thick, or as shading across the entire page. In either case there will be a film of toner on the drum surface.

Bad Developer Roller; This will show up as light print or as a mark that repeats every **32mm**

Machine Error Codes:

As with most of the newer Samsung models, the error codes are all in English and are self-explanatory. The biggest problems you will run into are paper jams, and a dirty scanner. Keeping the machine clean with periodic maintenance will take care of most of them.

Samsung SF-555P Toner Cartridges (Continued)

Lexmark E210 Printer Modification:

This modification is for the modification of the Samsung ML-1210 engine specifically the Lexmark E210. This modification will allow not only all of the ML-1210 cartridges to be tested, but the SF-550P and SF-5100 cartridges as well!

It is very simple to modify these printers so that they accept all versions of these cartridges for testing. That being said, please be aware that this will almost certainly void the warranty of the machine. Perform the following modification at your own risk.

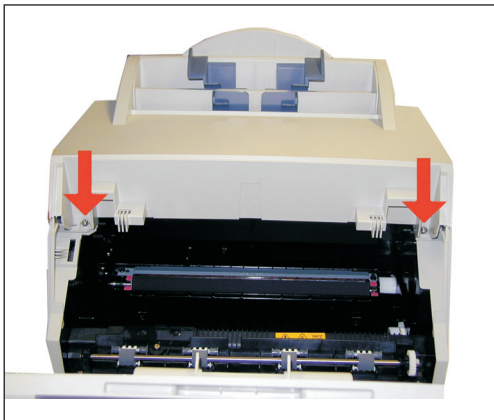

Figure 31

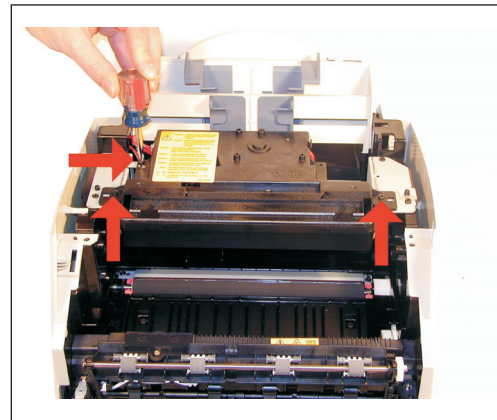

Figure 32

26) Remove the two top silver screws. The top cover will come loose. Lift up and remove the top cover. See Figure 31

27) Remove the three black screws from the laser unit. Carefully flip up the laser unit so that the metal tab is exposed. See Figure 32

You can see that with a total of eight slots, and the possibility of using more than one tab at a time, Samsung has quite a few options for cartridge variations!

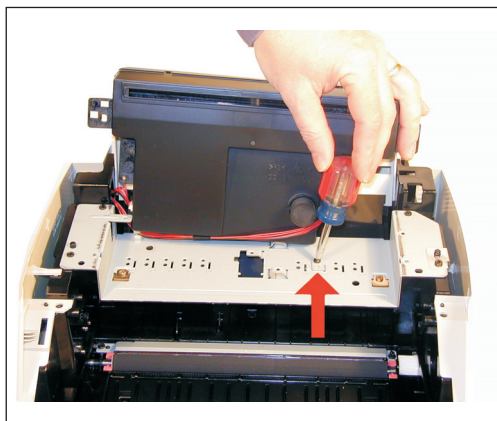

Figure 33



Figure 34

28) Remove the tab screw and tab. See Figure's 33 & 34

29) Replace the laser unit. Make sure that the alignment tabs are in their proper location, and that the cables are snug. Install the three screws.